

# S3i HANDHELD ADJUSTABLE DIMMER

The S3i Handheld Adjustable Dimmer is a dual color wireless controller which offers fast and accurate color temperature adjustment and independent dimming of each white. The touch color wheel can adjust color temperature from warm white to cool white. Independent smooth dimming of each white with a dimming range of 0.1% to 100%.



## SPECIFICATIONS

Output	RF Signal
Operating Frequency	868/915/434MHz
Power Supply	4.5V(3xAAA Battery)
Operating Temp	-32° F to +104° F
Relative Humidity	8% - 80%
Dimming Function	100% Down to 0.1%

Length	5.51" (140mm)
Width	1.89" (48mm)
Height	0.67" (17mm)
Requires S3i Receiver (NF-S3i-WR-1009)	

## OPERATION

### Pair with RF receivers:

1. Turn on the RF remote.
2. Click "Learning Key" on RF receiver.
3. Click a zone number: 1-6
4. Touch the color wheel  on the RF remote.

(LED Lights connected with the receiver will flicker once which means the receiver is paired with the remote controller)

For WiFi Functionality our WiFi RF Converter is required. (NF-S3i-WC-WIFI)

### How to delete the pairing:

Press and hold down "Learning Key" on the receiver for over 3 seconds until connected LED lights flicker twice, which means the pairing is deleted successfully.

### If you use multiple receivers, you have two choices:

Option 1: You can have all the receivers in the same zone, like zone 1.

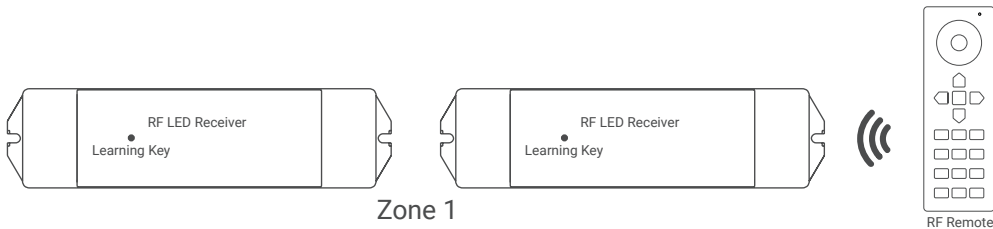

Option 2: You can have each receiver in a different zone, like zone 1, 2, 3 or 4.

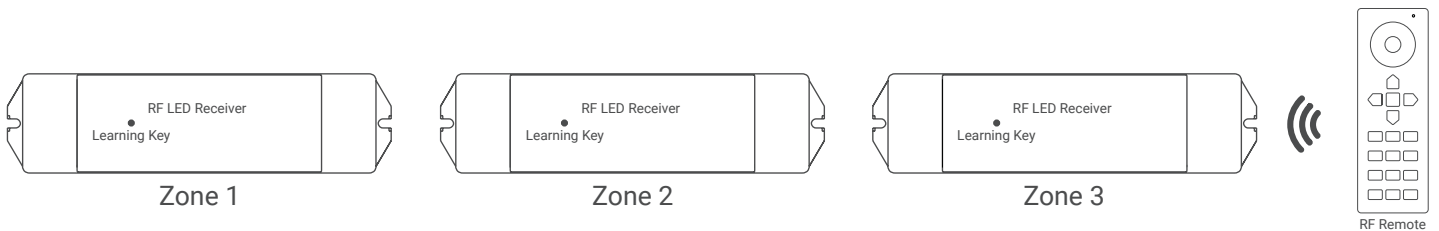

### Safety & Warnings:

- This device contains AAA batteries that should be stored and disposed properly.
- DO NOT expose the device to moisture.

# S3i HANDHELD ADJUSTABLE DIMMER

