

288W UNIVERSAL DIMMABLE DRIVER

NOVA FLEX[®]

Product Code: NF-PS-UNV-288W-24V

- Universal Dimming functions: 0-10V, 1-10V, potentiometer, 10V PWM, forward phase/leading edge/MLV and reverse phase/trailing edge/ELV TRIAC
- Can also be used in non-dimming configurations
- Works with static white, static color, adjustable, RGB, RGBW, and DRGB LED strip and neon
- Built-in active PFC (power factor correction)
- PWM output (pulse width modulation—doesn't change color index)
- DMX system compatible
- 0-10V dimming wires are capped and labeled to ensure they're only used when needed



Input

Voltage Range	120 – 277VAC
Frequency Range	47 – 63Hz
AC Current (Max)	3.4A @ 100VAC
Inrush Current	35A 50% 960µs @ 120VAC 43A 50% 1000µs @ 277VAC
Efficiency	87% @ 120VAC 91% @ 277VAC
Power Factor	0.99 @ 120VAC 0.97 @ 277VAC
THD	< 20%

Environment

Protection Rating	cULus Listed, UL 8750, Class 2, Type HL rated, FCC
Operating Temp	-40° to 140° F (-40° to 60° C) See derating curve in this spec doc
Storage Temp	-40° to 176° F (-40° to 80° C)
Expected Life	50,000 Hrs
Audible Noise	< 24dBA
Housing	Full protection metal housing for dry, damp, or wet locations (IP 66)

Protection

Over Temperature	212° ± 50° F shutdown o/p voltage, auto-recover after cooling
Over Load	Hiccup Mode ≤ 120%
Short Circuit	Shutdown o/p voltage, re-power to recover after fault condition removed
Customer Warranty	2 - 5 years (based on warranty of LED strip/neon purchased)

Output

Voltage	24 VDC
Power	288W (3×96)
Current	3×4A
Voltage Tolerance	± 0.5V
Voltage Regulation	± 0.5%
Load Regulation	± 1%
Minimum Load	10% = 28.8W

Dimming

Dimming Control	0-10V, 1-10V, potentiometer, 10V PWM, forward phase/leading edge/MLV and reverse phase/trailing edge/ELV TRIAC
Dimming Range Capability	0 - 100%, Flicker free (depends on dimmer type and specs)

Dimensions & Weight

Length	11.06 in.
Mounting Length	11.85 in.
Width with Cover	4.33 in.
Height with Cover	1.77 in.
Weight	5.51 lbs.

FOR MORE
INFORMATION
CLICK HERE



CUSTOMIZATION
MODEL

INSTALLATION GUIDES

DIMMER REFERENCE

UNIVERSAL DIMMABLE DRIVER

Product Code: NF-PS-UNV-288W-24V

Notes

- This driver should be installed by a qualified professional
- If using potentiometer dimming, the resistor should be $\geq 100\text{K}\Omega$, otherwise dimming performance will be compromised
- Please make sure the driver is installed with adequate ventilation to allow for heat dissipation
- Contact an integrator to set up your DMX/DRGB configuration
- Ensure that wiring is correct in order to avoid light and power supply damage
- The purple and gray dimming wires are only for use with 0-10V, 1-10V, potentiometer and 10V PWM dimming configurations. They should be capped when not in use (see photo at right)

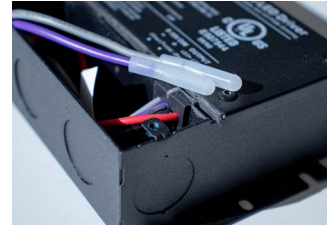

Wiring Diagrams

TRIAC / PHASE CUT DIMMING



- The Pulse-Width Modulation (PWM) for output voltage can be adjusted through input terminal of the AC phase line(L), by connecting a phase/ TRIAC dimmer
- Works with forward phase/leading edge, MLV and reverse phase/trailing edge, ELV, TRIAC dimmers
- Please use dimmers with power ≥ 1.5 times the output power of the driver

0-10V/1-10V DIMMING, WITH DIMMER ON INPUT SIDE

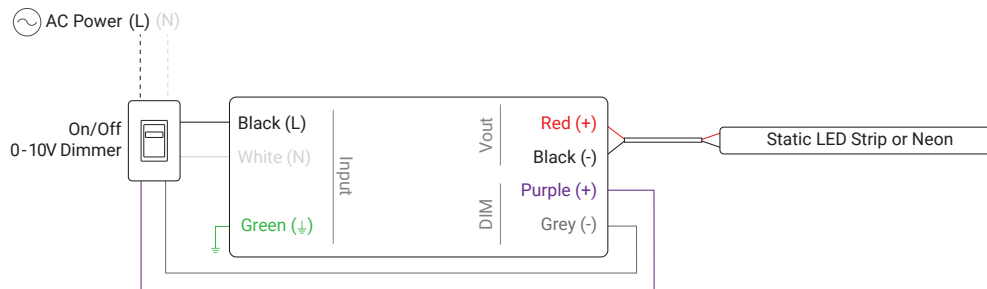

- The 0-10V/1-10V dimmer is on the input side so it can control dimming and on/off functions

0-10V/1-10V DIMMING, WITH ON/OFF SWITCH ON INPUT SIDE

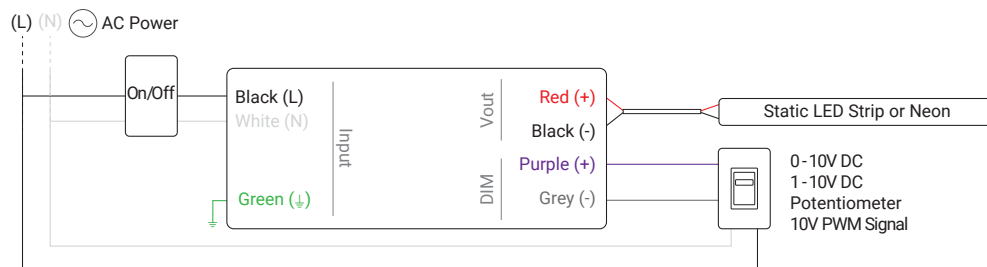

- The on/off switch is on the input side. 0-10V/1-10V controls dimming only, not on/off function

NOVA FLEX STATIC DIMMER TOUCH PANEL CONTROL (NF-S3I-TP-D) AND WIRELESS RECEIVER (NF-S3I-WR-1009)

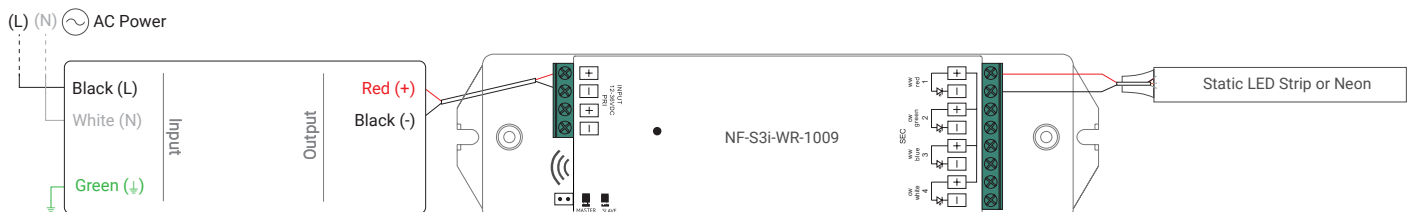

UNIVERSAL DIMMABLE DRIVER

Product Code: NF-PS-UNV-288W-24V

Wiring Diagrams

NOVA FLEX ADJUSTABLE TOUCH PANEL CONTROL (NF-S3I-TP-AS) AND WIRELESS RECEIVER (NF-S3I-WR-1009)

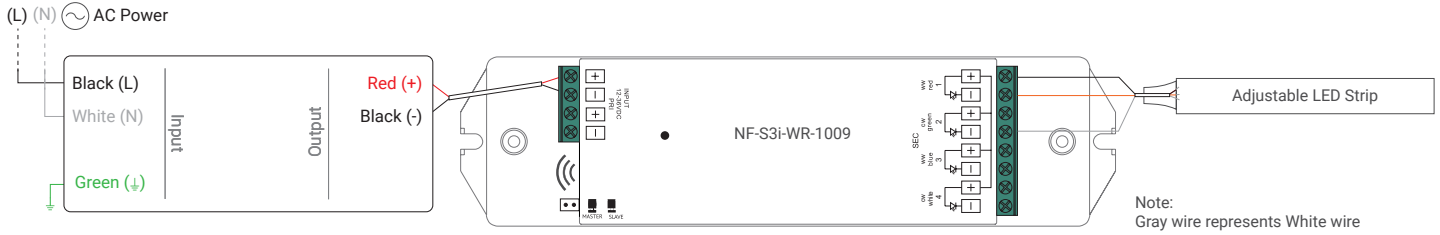

NOVA FLEX RGB TOUCH PANEL CONTROL (NF-S3I-TP-RGB) AND WIRELESS RECEIVER (NF-S3I-WR-1009)

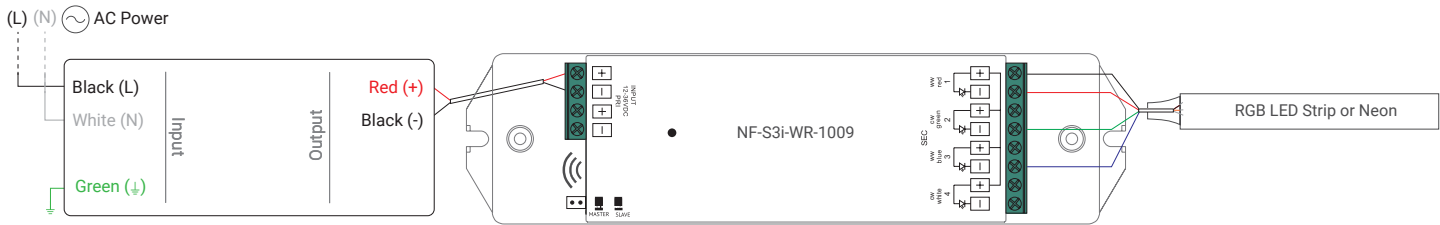

NOVA FLEX RGBW TOUCH PANEL CONTROL (NF-S3I-TP-RGBW) AND WIRELESS RECEIVER (NF-S3I-WR-1009)

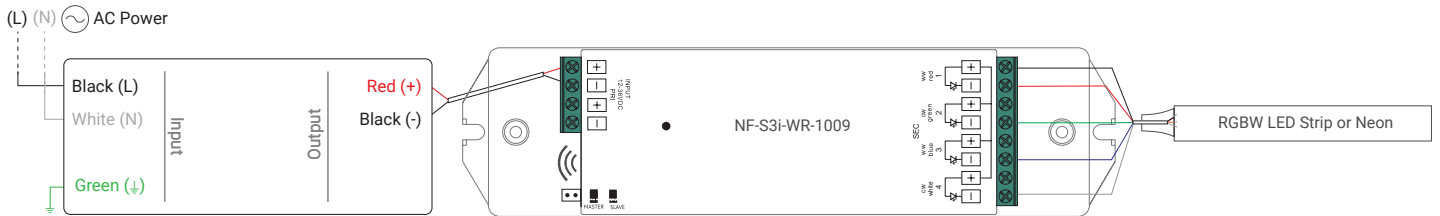

Spec Drawing

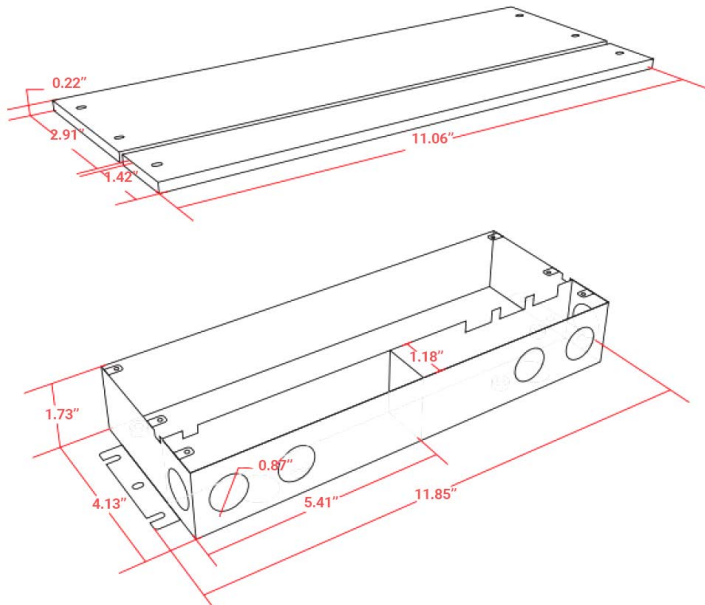

UNIVERSAL DIMMABLE DRIVER

Product Code: NF-PS-UNV-288W-24V

Derating Curve

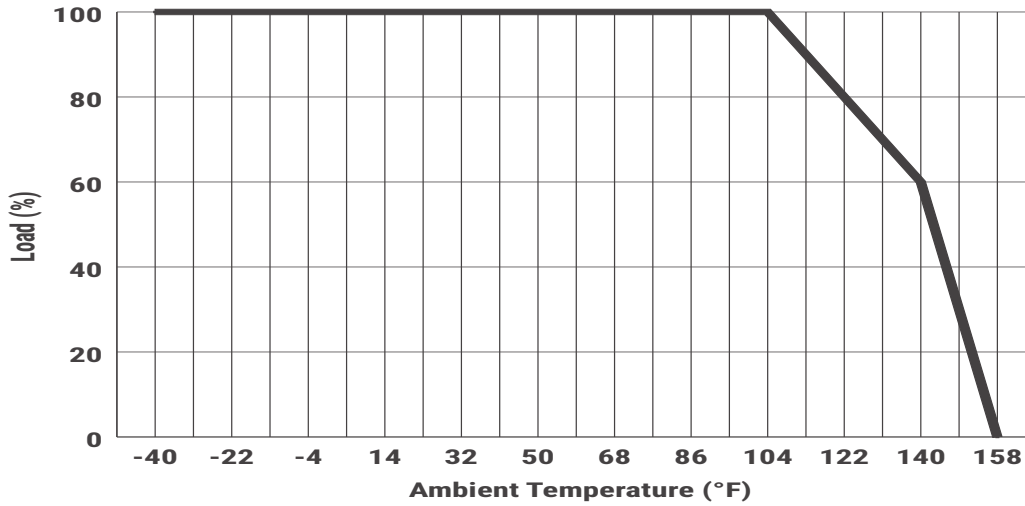

Dimming Curves

Dimming curve: linear



Dimming curve: logarithmic

