

# AQUEOUS NEON SERIES

The Aqueous Neon Series is certified to the highest standard, UL676, making it safe for use in swimming pools and other inhabitable bodies of water.

- Submersible / Inhabitable
- Commercial / Residential
- Pools / Spas



ORDER CODE	SERIES	ENV	VOLTAGE	CCT
NF	NEON	UW	24V	
NF	NEON	UW = IP68	24V	SEE TABLE

# NOVA FLEX®



## Physical

Operating Temp	-15° to 140°F (-25° to 60°C)
Environment	IP68 Rugged (Water/chemical resistant)
Cut Marks	2.19", except 3.28" for red
Required Mounting	Channel
Required Lead	16.4 ft or 32.8 ft

## Performance

Lumen Maintenance	50,000 Hrs
Warranty	3 years
CCT Binning	3-step MacAdam
Certifications	UL676

## Electrical

Voltage	24V
Wire Size	18 AWG. 2 Wire
Jumper	None allowed
Dimming	MLV   0-10V   S3i Series Controller

## Dimensions

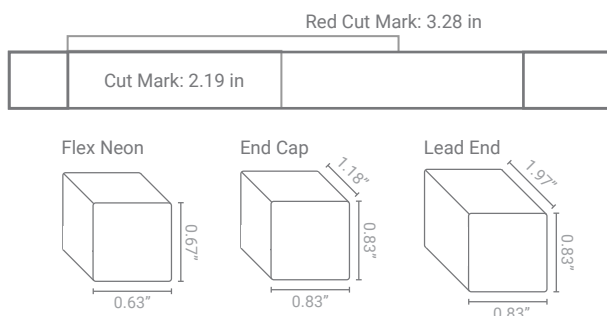

CCT	CRI	Lumens/ft	Efficacy (lm/w)	Power (w/ft)	Max Run
2700K*	83	153	44		26.2 ft
3000K*	82	164	49	3.4	
5700K*	83	151	45		
Red*	N/A	57	26	2.2	
Green*	N/A	155	46	3.4	
Blue*	N/A	25	7		

Lumens have a tolerance of +/- 10%.

## Complete Solution

Step 1	Build the LED neon order code
Step 2	Select lead option and channel
Step 3	Select power and controls
Step 4	Select accessories
Step 5	Contact your Agent or Nova Flex

## Channel

Product Code	NF-CH-UW-1M (1M length) NF-CH-UW-35MM (35mm length)
Material	Clear Plastic

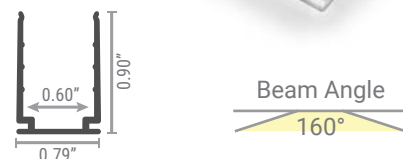

[INSTALL GUIDE](#) [PHOTOMETRICS](#)











# AQUEOUS NEON DRIVER OPTIONS

	Product Image	Product Code	Wattage	Current/Voltage	Safety	Downloads
Universal Dim / Non-Dim		NF-PS-UNV-60W-24V Dim 0-10V, MLV, ELV TRIAC View spec sheet for all options	60W	Output Current: 2.5A Input Voltage: 100-277 VAC	UL8750 Class 2 Type HL FCC	<a href="#">SPEC SHEET</a>
		NF-PS-UNV-96W-24V Dim 0-10V, MLV, ELV TRIAC View spec sheet for all options	96W	Output Current: 4A Input Voltage: 100-277 VAC	UL8750 Class 2 Type HL FCC	<a href="#">SPEC SHEET</a>
		NF-PS-UNV-288W-24V Dim 0-10V, MLV, ELV TRIAC View spec sheet for all options	288W	Output Current: 3x4A Input Voltage: 100-277 VAC	UL8750 Class 2 Type HL FCC	<a href="#">SPEC SHEET</a>
		NF-PS-UNV-384W-24V Dim 0-10V, MLV, ELV TRIAC View spec sheet for all options	384W	Output Current: 4x4A Input Voltage: 100-277 VAC	UL8750 Class 2 Type HL FCC	<a href="#">SPEC SHEET</a>
0 - 10V Dim Only		NF-PS-MAXX-30W-24V-0/10V	30W	Output Current: 1.25A Input Voltage: 100-277 VAC	UL8750 Class 2 Type HL FCC	<a href="#">SPEC SHEET</a>
		NF-PS-MAXX-288W-24V-0/10V	288W	Output Current: 20A Input Voltage: 100-277 VAC	UL 7850 UL1310	<a href="#">SPEC SHEET</a>
		NF-PS-96W-24V-0/10V	96W	Output Current: 0.96A Max Input Voltage: 120-277 VAC	UL8750 Class 2	<a href="#">SPEC SHEET</a>
Lutron		NF-PS-L3DA-40W-24V-KL Lutron Hi-Lume 1% EcoSystem/3-Wire 24V	40W	Output Current: 3.3A Input Voltage: 120-277 VAC	UL8750 Class 2 Type TL	<a href="#">SPEC SHEET</a>
		NF-PS-L3DO-96W-24V Lutron Hi-Lume Premier 0.1% EcoSystem/3-Wire 24V Constant Voltage	96W	Output Current: 4.0A Input Voltage: 120-277VAC	UL8750 CSA250.13-14 Class 2	<a href="#">SPEC SHEET</a>

	Product Image	Product Code	Details	Downloads
S3i Series		<b>S3i Glass Touch-Panel</b> NF-S3i-TP-D	Required to Pair: S3i-WR-1009 Zones: 4 Power Consumption: 200ma Dimming Function: 0 - 100%	<a href="#">SPEC SHEET</a>
		<b>S3i Hand-Held Remote</b> NF-S3i-WC-D	Required to Pair: S3i-WR-1009 Zones: 6 Dimming Function: 0 - 100% Battery Operated: 3 AAA	<a href="#">SPEC SHEET</a>
		<b>S3i Push Button Wall Mount</b> NF-S3i-PB-D	Required to Pair: S3i-WR-1009 Zones: 1 Dimming Function: 0 - 100% Battery Operated: 3V (CR2025)	<a href="#">SPEC SHEET</a>
		<b>S3i Wireless Receiver</b> All controls above require this product NF-S3i-WR-1009	Output Power: 240 - 720w Output Current: 4 CH. 5A/CH Input: 12 - 36V DC Dimming: 0 - 100% Can pair with NF-A-UNV	<a href="#">SPEC SHEET</a>
Amplifier		<b>Universal Amplifier</b> NF-A-UNV	Input Voltage: 12 - 36V DC Input Signal: PWM Max Load Current: 20A (5A/4CH) Max Output Power: 240 - 720W	<a href="#">SPEC SHEET</a>

# AQUEOUS NEON ACCESSORY OPTIONS



Product Image	Product Code	Dimensions
	<b>Hardwire to Female Quick Connect Adapter</b> NF-C-F	Available Lengths: 6in, 1ft, 2ft, 3ft, 4ft, 5ft, 6ft, & 10ft
	<b>Hardwire to Male Quick Connect Adapter</b> NF-C-M	Available Lengths: 6in, 1ft, 2ft, 3ft, 4ft, 5ft, 6ft, 8ft & 10ft
	<b>Male to Female Quick Connect Adapter</b> NF-C-MF	Available Lengths: 3ft, 6ft & 10ft
	<b>Y Cable</b> 2 Male, 1 Female NF-C-Y	Total Length: 20.00 in
	<b>Y Cable</b> 4 Male, 1 Female NF-C-Y-4Y	Total Length: 20.00 in
	<b>Y Cable</b> 8 Male, 1 Female NF-C-Y-8Y	Total Length: 17.25 in
	<b>Female Quick Connect to Hardwire Adapter</b> NF-C-F/HW	1.5 x 0.5 x 0.5 in
	<b>Male Quick Connect to Hardwire Adapter</b> NF-C-M/HW	1.5 x 0.5 x 0.5 in
	<b>Hard Clips</b> 20 per pack NF-CLIPS-H	1.125 x 0.25 in Clips add 0.125" to height of lights
	<b>Soft Clips</b> 20 per pack NF-CLIPS-S	1.125 x 0.25 in Clips add 0.125" to height of lights
	<b>Universal Adjustable Clip</b> NF-CH-UNV-CLIPS/ADJ	1.13 x 1.00 in

FOR MORE  
INFORMATION  
CLICK HERE 

RESOURCES

WHY NOVA FLEX

ADDITIONAL  
PRODUCT OPTIONS