

MINI NEON SERIES

The Mini Neon Series offers architectural-grade LED neon in static white & color with a tighter radius to allow more flexibility.

- Indoor / Outdoor
- UV, Chemical, & Saltwater Resistant



ORDER CODE	LED	ENV	SERIES	VOLTAGE	CCT
NF NF/SP*	NEON NEON	W W = IP68	MINI MINI	24V 24V	SEE TABLE

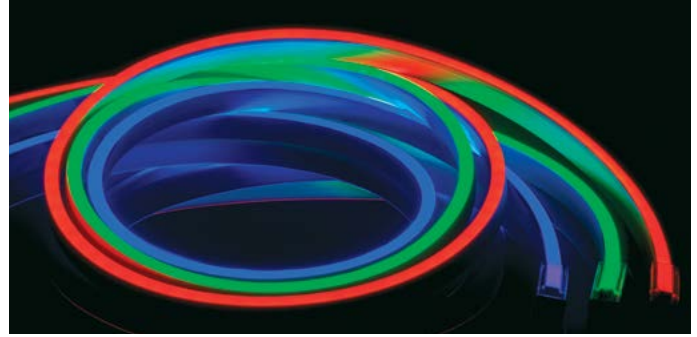

Physical

Operating Temp	-15° to 140°F (-25° to 60°C)
Environment	IP68 Rugged (Water/chemical resistant)
Cut Marks	3.28", except 4.92" for red
Mounting	Clips Channel (Required)
Lead Options	Standard Injection Molded* Right, Bottom, Left and Back
Bend Diameter	3.54 in

Performance

Lumen Maintenance	50,000 Hrs
Warranty	3 years
CCT Binning	3-step MacAdam
Certifications	UL Wildlife Certified (Red / Yellow)

Electrical

Voltage	24V
Wire Size	18 AWG. 2 Wire
Lead	1M, 3M, or 5M
Jumper	6 Inch or 12 Inch
Dimming	MLV 0-10V S3i Series Controller

Dimensions

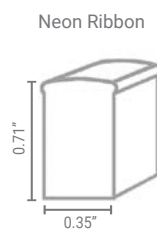
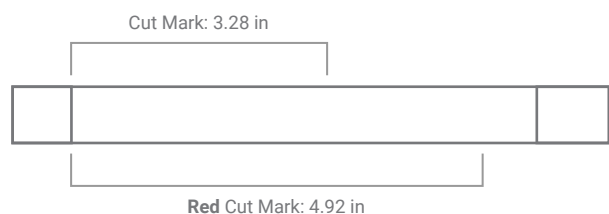

Lead options & dimensions on next page

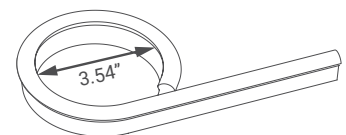

CCT	Lumens/ft	Efficacy (lm/w)	Power (w/ft)	Max Run
2700K	27	19		
3000K	27	19		
3500K	30	22	1.4	
4000K*	39	31		
5000K	30	22		49.2 ft
Red	13	12	1.0	
Green	24	22		
Blue	5	4	1.4	
Yellow*	15	14		

Lumens have a tolerance of +/- 10%.

Complete Solution

Step 1	Build the LED neon order code
Step 2	Select lead options, channel or clips
Step 3	Select power and controls
Step 4	Select accessories
Step 5	Contact your Agent or Nova Flex

Lead Options

Standard Lead Options

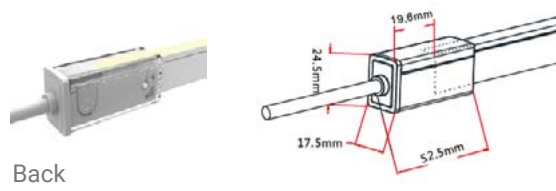
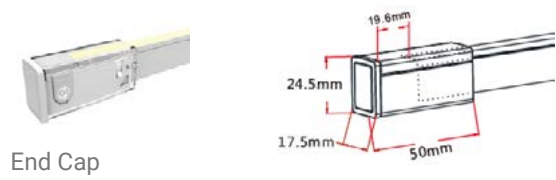

Right or Left Side and Bottom are also available in standard lead options. Images & dimensions coming soon.

Injection Molded Leads (special order, no MOQ)*

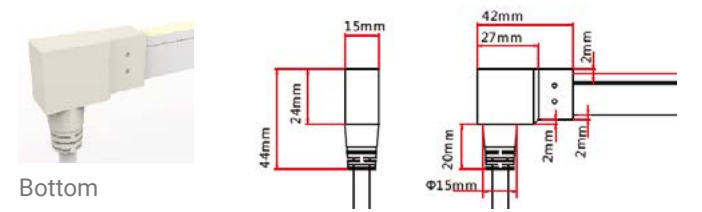
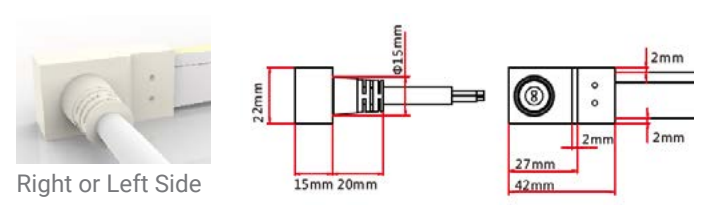
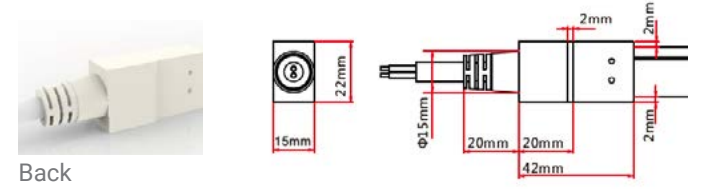
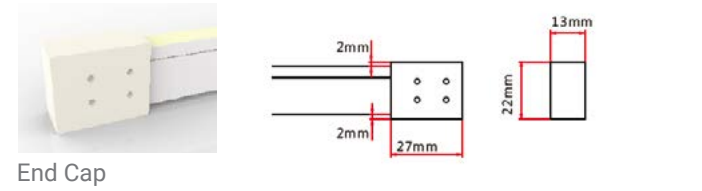

Channel or Clip Options

Self-Locking Channel or Clips to create the perfect design.

Channel	NF-CH-NEON-MINI-SL-2M
Clip	NF-CH-NEON-MINI-SL-CLIP
Material	Anodized Aluminum
Length	Custom Length up to 2M
Color	Silver

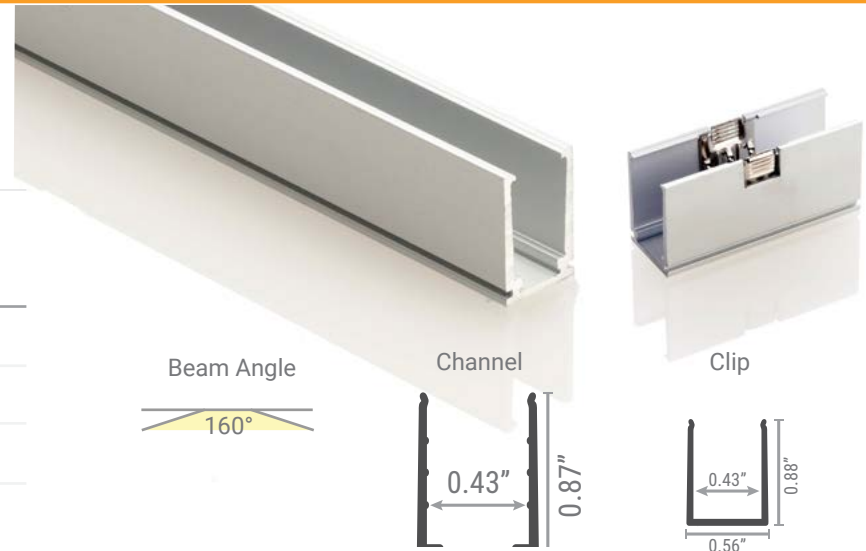

*Special Order requires lead-time of 7 - 9 weeks. MOQ Neon 164 feet | MOQ Channel 150 pcs (2M/pc)

MINI NEON DRIVER OPTIONS

	Product Image	Product Code	Wattage	Current/Voltage	Safety	Downloads
Universal Dim / Non-Dim		NF-PS-UNV-60W-24V Dim 0-10V, MLV, ELV TRIAC View spec sheet for all options	60W	Output Current: 2.5A Input Voltage: 100-277 VAC	UL8750 Class 2 Type HL FCC	SPEC SHEET
		NF-PS-UNV-96W-24V Dim 0-10V, MLV, ELV TRIAC View spec sheet for all options	96W	Output Current: 4A Input Voltage: 100-277 VAC	UL8750 Class 2 Type HL FCC	SPEC SHEET
		NF-PS-UNV-288W-24V Dim 0-10V, MLV, ELV TRIAC View spec sheet for all options	288W	Output Current: 3x4A Input Voltage: 100-277 VAC	UL8750 Class 2 Type HL FCC	SPEC SHEET
		NF-PS-UNV-384W-24V Dim 0-10V, MLV, ELV TRIAC View spec sheet for all options	384W	Output Current: 4x4A Input Voltage: 100-277 VAC	UL8750 Class 2 Type HL FCC	SPEC SHEET
0 - 10V Dim Only		NF-PS-MAXX-30W-24V-0/10V	30W	Output Current: 1.25A Input Voltage: 100-277 VAC	UL8750 Class 2 Type HL FCC	SPEC SHEET
		NF-PS-MAXX-288W-24V-0/10V	288W	Output Current: 20A Input Voltage: 100-277 VAC	UL 7850 UL1310	SPEC SHEET
		NF-PS-96W-24V-0/10V	96W	Output Current: 0.96A Max Input Voltage: 120-277 VAC	UL8750 Class 2	SPEC SHEET
Lutron		NF-PS-L3DA-40W-24V-KL Lutron Hi-Lume 1% EcoSystem/3-Wire 24V	40W	Output Current: 3.3A Input Voltage: 120-277 VAC	UL8750 Class 2 Type TL	SPEC SHEET
		NF-PS-L3DO-96W-24V Lutron Hi-Lume Premier 0.1% EcoSystem/3-Wire 24V Constant Voltage	96W	Output Current: 4.0A Input Voltage: 120-277VAC	UL8750 CSA250.13-14 Class 2	SPEC SHEET

	Product Image	Product Code	Details	Downloads
S3i Series		S3i Glass Touch-Panel NF-S3i-TP-D	Required to Pair: S3i-WR-1009 Zones: 4 Power Consumption: 200ma Dimming Function: 0 - 100%	SPEC SHEET
		S3i Hand-Held Remote NF-S3i-WC-D	Required to Pair: S3i-WR-1009 Zones: 6 Dimming Function: 0 - 100% Battery Operated: 3 AAA	SPEC SHEET
		S3i Push Button Wall Mount NF-S3i-PB-D	Required to Pair: S3i-WR-1009 Zones: 1 Dimming Function: 0 - 100% Battery Operated: 3V (CR2025)	SPEC SHEET
		S3i Wireless Receiver All controls above require this product NF-S3i-WR-1009	Output Power: 240 - 720w Output Current: 4 CH. 5A/CH Input: 12 - 36V DC Dimming: 0 - 100% Can pair with NF-A-UNV	SPEC SHEET
Amplifier		Universal Amplifier NF-A-UNV	Input Voltage: 12 - 36V DC Input Signal: PWM Max Load Current: 20A (5A/4CH) Max Output Power: 240 - 720W	SPEC SHEET

MINI NEON ACCESSORY OPTIONS

Product Image	Product Code	Dimensions
	Hardwire to Female Quick Connect Adapter NF-C-F	Available Lengths: 6in, 1ft, 2ft, 3ft, 4ft, 5ft, 6ft, & 10ft
	Hardwire to Male Quick Connect Adapter NF-C-M	Available Lengths: 6in, 1ft, 2ft, 3ft, 4ft, 5ft, 6ft, 8ft & 10ft
	Male to Female Quick Connect Adapter NF-C-MF	Available Lengths: 3ft, 6ft & 10ft
	Y Cable 2 Male, 1 Female NF-C-Y	Total Length: 20.00 in
	Y Cable 4 Male, 1 Female NF-C-Y-4Y	Total Length: 20.00 in
	Y Cable 8 Male, 1 Female NF-C-Y-8Y	Total Length: 17.25 in
	Female Quick Connect to Hardwire Adapter NF-C-F/HW	1.5 x 0.5 x 0.5 in
	Male Quick Connect to Hardwire Adapter NF-C-M/HW	1.5 x 0.5 x 0.5 in
	Hard Clips 20 per pack NF-CLIPS-H	1.125 x 0.25 in Clips add 0.125" to height of lights
	Soft Clips 20 per pack NF-CLIPS-S	1.125 x 0.25 in Clips add 0.125" to height of lights
	Universal Adjustable Clip NF-CH-UNV-CLIPS/ADJ	1.13 x 1.00 in

FOR MORE INFORMATION
CLICK HERE

RESOURCES

WHY NOVA FLEX

ADDITIONAL
PRODUCT OPTIONS