

# ColorFlood Square C-SS2-RGBW-10S-24

24-LED Adjustable RGBW  
Square Flood/Spot DMX Light

CAT. NO.: \_\_\_\_\_  
TYPE: \_\_\_\_\_  
PROJECT: \_\_\_\_\_



## APPLICATION



For use as linear, direct flood and/or accent lighting, installed as an above grade fixture. Perfect for applications desiring a dynamic color changing effect. Recommended for retail, modern residential, hospitality and entertainment installations. RGBW design allows fine-tuned pastel colors and saturated hues without sacrificing illumination brightness. DMX control option allows the use of DMX512 Control Systems to individually control and change colors, set looks, and add lighting effects which can affect moods, feelings and atmosphere.

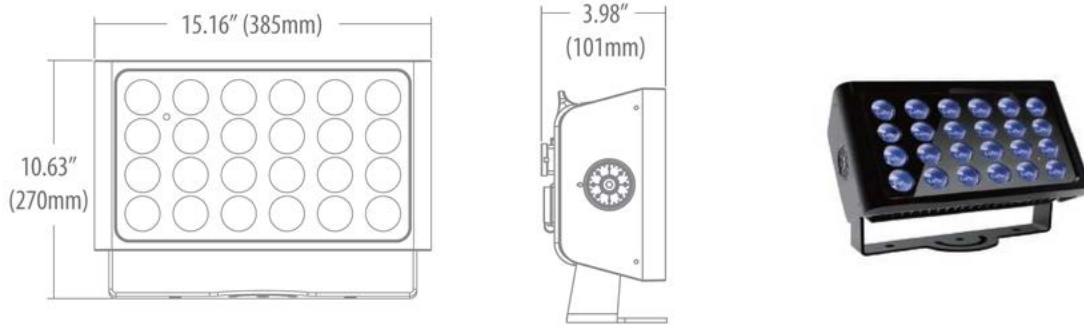

- 161W (24-LED) 5,196 Max. Lumen
- DMX direct via LCD display, Proprietary quick connectors included
- IP65
- 40° beam spread
- LED Die Colors: RGBW
- RDM function
- 16-bit dimming way
- Using proprietary technology, colors are efficiently blended together through an internal mixing chamber. The one-color output reduces unsightly views of isolated rainbow like striations.
- Smooth and flicker-free dimming of all colors down to 1%
- 3 Year Warranty

## DIMENSIONS



## ACCESSORIES

60" Plug-In Cord (in addition to cord included with unit) For connecting mains power to unit. Terminated in a 15A male Edison connector.	C-SWR-PWR-WL-60-PI 
80" Power Jumper For daisy chaining power from powered unit to unpowered unit. No more than 9 units max from mains power feed.	C-SWR-PWR-WL-80 
300" (25') Data Cable Interconnect For daisy chaining DMX from one fixture to another. Pre-terminated in 4-Pin proprietary connector. Maximum 32 fixtures may be connected on any DMX run (for bare-end at one end, please specify -HW).	C-SWR-DMX-WL-300 

80" DMX/Data Jumper For daisy chaining DMX from one fixture to another. Pre-terminated in 4-Pin proprietary connector. Maximum 32 fixtures may be connected on any DMX run (for bare-end at one end, please specify -HW).	C-SWR-DMX-WL-80 
Wet Location Power End Cap (in addition to the set included with unit) Protective cover for use in wet location environments for capping power connector cable.	C-PCL008-WL-PWR 
Wet Location DMX End Cap (in addition to the set included with unit) Protective cover for use in wet location environments to cap DMX cables. Not a DMX terminator.	C-PCL008-WL-DMX 

2022.03.01

# ColorFlood Square C-SS2-RGBW-10S-24

24-LED Adjustable RGBW

coloronix  
by NOVA FLEX

## SPECIFICATIONS

### OUTPUT

Beam Angle: 40°

Lumens: 5,196 Max. Lumen

Efficacy (lm/W): 32.27 lm/W

LED Channels: Red/Green/Blue/White

Color Mixing: Using proprietary technology, colors are efficiently blended together through an internal mixing chamber. The one-color output reduces unsightly views of isolated Red, Green and Blue Diodes for a seamless rainbow-free appearance.

### ELECTRICAL

Input Voltage: Direct 120-277V input comes standard. 50/60 Hz

Power Consumption: 161W

### CONTROL

Interface: DMX direct via LCD display

Control System: DirectDMX Color Control. Color controlled with USITT DMX512A Standard Protocol to work with Coloronix or 3rd Party DMX Systems. On board LCD display inside the Data Enabler allow selecting of DMX addresses between 1-512 in a given DMX universe. DMX Data fed to housing via proprietary 4-wire data cable. Data Input/Output ports allow daisy-chaining of DMX Signal.

LED Die Colors: Red (620-635nm), Green (520-535nm), Blue (450-465nm) and Neutral White (4000K)

Dimming: Smooth and flicker-free dimming of all colors down to 1%

Stand Alone Control: Pre-Programmed static and dynamic scenes, as well as specific colors, can be user activated by the integral Data Enabler's computer eliminating the need for an external data source. On board OLED display inside the Data Enabler allows selection of over 30 static and dynamic color sequences. Display encased behind temperproof UV protected glass to reduce deterioration after long exposure to outdoor environments.

### LUMEN MAINTENANCE

L70 Life: 35,000 Hours for ambient temperatures under 100°F.

### PHYSICAL

Dimensions (Height x Width x Length): 10.63" x 3.98" x 15.16"

Housing Material: Die-cast magnesium alloy to protect light emitting diodes, other electronics and preserve optical alignment. Painted black to maximize color mixing and eliminate stray light leaks. Integral split yoke allows for 90° tilt.

Weight: 7.8 lbs. (3.55kg)

Lens: PMMA Impact Resistant

Mounting: Split yoke provided for pipe, truss or surface mounting. Pre-drilled mounting holes on yoke.

Temperature Range: 14°F - 104°F Ambient

### ENVIRONMENT

IP65

### CERTIFICATION

ETL listing is pending/coming soon



### WARRANTY

3-Years

The SS2 Series are active, top-of-the-line RGBW color changing fixtures that can be used in indoor or outdoor projects. They draw on solid-state elements, to produce highlights and washes in architectural spaces. RGBW is an acronym for Red Green Blue and White. RGBW LED color mixing luminaires have the potential to produce 4.3 billion colors and 16.7 million white light tones.

When installed and operated according to this manual, these fixtures will operate safely and dependably for their rated lifespan.

These luminaries require a USITT DMX 512 control signal on four consecutive channels total. The unit includes a DATA OUT output for connection to additional units or other DMX512 devices.

## SCOPE

The purpose of this manual is to show proper use and installation of color-changing flood lights for peak performance. This manual must be complimented by additional references, consultation from qualified professional(s), and observance of state and local codes and regulations. This rule applies to any interior structure, exterior structure, or environment.

Therefore, it is important to: **please read and comply with all instructions and warnings in this manual when installing or using this product.**

**THIS MANUAL INTENDED FOR** electrical contractors, electrical engineers, and licensed electricians.

## ADDITIONAL SUPPLY OPTIONS

- DMX512 compatible controller (optional)
- DMX extension (optional)
- DMX feed connector
- 4x4 inch electrical junction box rated for the application (optional)
- Controller (DMX512 compatible)
- Proper mounting bolts, washers, and lock washers to secure the fixture to the mounting surface

## SAFETY HAZARD ICON KEY



**DANGER** = avoiding *pending* danger will result in serious injury or death.













**WARNING** = avoiding this warning may result may in serious injury or death.



**CAUTION** = not exercising caution may result in minor to moderate injury, or property damage.

## SAFETY HAZARD PRECAUTIONS

-  **DANGER:** Not turning off the main power before wiring, installing, connecting, or disconnecting this product may result in serious injury, or death.
-  **WARNING:** Not following NEC codes, local codes, or consulting a certified professional may result in property damage, serious injury, or death.
-  **WARNING:** Not following instructions or safety labels may result in property damage, or serious injury.
-  **WARNING:** Modifying, servicing, or ignoring these safety indications may void the warranty.
-  **WARNING:** Inspect product before use. DO NOT use if damaged.
-  **WARNING:** Install safety cables per local and structural engineer's code.
-  **CAUTION:** Hot swapping, not turning off fixtures before connection or disconnection, will void the warranty, and damage property.
-  **CAUTION:** Do not go beyond the specified voltage, input current, maximum number of fixtures, or run length.
-  **CAUTION:** Do not use sharp tools near the reflector or lens.
-  **CAUTION:** Do not look directly into beam, with or without optical instruments.

Note: Instructions and warning referenced in this installation guide are not necessarily all-inclusive, all conceivable, or all relevant to all applications as Coloronix by Nova Flex cannot anticipate all conceivable or unique situations.

## PLANNING FOR INSTALLATION

**Unpacking:** Use the packing list to ensure all accessories are included. Survey the unit to make sure the data enabler/trim are all intact—not cracked or damaged. Please recycle or appropriately discard of any packing materials.

**Preparation:** Before Installation, we suggest:

- Consult the provided submittal drawings to recognize layouts of luminaries, power supplies, & wiring layouts
- Drawing out a layout plan consisting of locations of luminaries and wiring
- Record DMX addresses on a mapping grid for easy reference and addressing (where applicable)
- An electrical inspector reviews all wiring plans

### Points to Consider About Data:

- AC Power and DATA cables may NOT run in the same conduit or within one
- foot due to possible induced errors.
- 32 DMX DATA links max per run

### To Install Successfully:

1. Mount and align fixture
2. AC power connections
3. DMX connections

### SETTING COLOR MODE

For installations requiring DMX control, set the personalized DMX address on the LCD menu (pictured at right) using the address table below.

**Note:** Up to 128 unique 4-channel addresses can be set per DMX universe. The factory default setting for this unit is 4-channels.

**Lock Function:** If MENU is IDLE for 20 seconds, MENU will lock. Hold MENU and “DOWN” button to release lock.

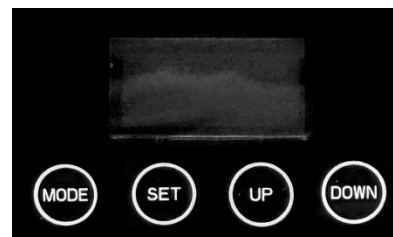

**Operation Mode Transformation** – press ‘MODE’, then ‘UP’ or ‘DOWN’ button to transform menus:

1. DMX
2. Slave
3. AUTO
4. Program
5. Dimmer
6. Settings
7. Information

**DMX Mode** – press the setup button to enter and select ‘UP’ or ‘DOWN’ button:

Address	001 - 512
Channels	4 / 6/ 10 ch

### DMX Channels

Function	DMX Value	Setting	4 Ch	6 Ch	10 Ch
Dimmer	000-255	0 - 100%		1	1
Strobe	0-10	No function		2	2
Linear	11-255	Slow to fast			
Strobe FX	0-10	No function			3
	11-255	Random strobe slow to fast			
Red	000-255	0 - 100%	1	3	7
Green	000-255	0 - 100%	2	4	8
Blue	000-255	0 - 100%	3	5	9
White	000-255	0 - 100%	4	6	10
Color Preset	000-007	R (0) G (0) B (0) W (0)			4
	008-013				
	014-020	R (255) G (0) B (0) W (0)			
	021-027	R (255) G (0) B (0) W (100)			
	028-034	R (255) G (0) B (0) W (200)			
	035-041	R (255) G (150) B (0) W (0)			
	042-048	R (255) G (255) B (0) W (0)			
	049-055	R (255) G (255) B (0) W (75)			
	056-062	R (0) G (255) B (0) W (255)			
	063-069	R (0) G (255) B (0) W (150)			
	070-076	R (0) G (255) B (0) W (50)			
077-083	R (0) G (255) B (0) W (0)				

	084-090	R (0) G (255) B (50) W (0)			
	091-097	R (0) G (255) B (150) W (0)			
	098-104	R (0) G (255) B (255) W (0)			
	105-111	R (0) G (255) B (255) W (75)			
	112-118	R (0) G (255) B (255) W (150)			
	119-125	R (0) G (100) B (255) W (255)			
	126-132	R (0) G (0) B (255) W (100)			
	133-139	R (0) G (0) B (255) W (50)			
	140-146	R (0) G (0) B (255) W (0)			
	147-153	R (75) G (0) B (255) W (0)			
	154-160	R (160) G (0) B (255) W (0)			
	161-167	R (255) G (0) B (255) W (0)			
	168-174	R (255) G (0) B (175) W (0)			
	175-181	R (255) G (0) B (100) W (0)			
	182-188	R (255) G (0) B (100) W (50)			
	189-195	R (255) G (0) B (25) W (50)			
	196-202	R (255) G (0) B (25) W (25)			
	203-209	R (255) G (0) B (25) W (0)			
	210-216	R (0) G (0) B (0) W (255)			
	217-223	R (75) G (75) B (0) W (255)			
	224-230	R (0) G (0) B (100) W (255)			
	231-255	R (255) G (255) B (255) W (255)			
Color Running	000-015	No function			5
	016-031	Jump 1			
	032-047	Jump 2			
	048-063	Jump 3			
	064-079	Jump 4			
	080-095	Jump 5			
	096-111	Jump 6			
	112-127	Jump 7			
	128-143	Jump 8			
	144-159	Fade 1			
	160-175	Fade 2			
	176-191	Fade 3			
	192-207	Fade 4			
	208-223	Fade 5			
224-239	Fade 6				
	240-255	Fade 7			
Speed	0-255	Slow to fast	Color running		6

**Dimming Mode:** Press the setup button to enter and select by the 'UP' or 'DOWN' button:

Dimmer	Red	000 - 255
	Green	000 - 255
	Blue	000 - 255
	White	000 - 255

**Auto Mode:** Press the setup button to enter, choose YES. Lights will run according to the speed and strobe of built-in Program Mode:02-Program Mode:14

**Built-In Program:** There are 16 built-in programs. Press the setup button to enter and 'UP' or 'DOWN' button

Mode:01 static color	Color	00-33
	Strobe	00-99

Mode:02-16 built-in program	Speed	001-100
	Strobe	00-99

**Slave Mode:** Press the setup button to enter, choose YES. After connect the DMX cable, the light will run with the main fixture at the same step

**Settings:** Press the setup button to enter and 'UP' or 'DOWN' button:

Settings	Curves Select
	Dimmer Speed
	DMX Fail
	DMX Sync
	Lock
	Factory Reset

1. Dimming curve settings – there are four available. Press the setup button to enter and select by the 'UP' or 'DOWN' button:

Curves	1: linear
	2: square law
	3: Inv square law
	4: S-type

2. Dimmer Speed - Press the setup button to enter and select by the 'UP' or 'DOWN' button:

Dimmer Speed	Fast
	Smooth

3. DMX Fail console DMX signal clear - Press the setup button to enter and select by the 'UP' or 'DOWN' button:

DMX Fail	Off	When DMX signal connection fail, light off
	Hold	When DMX signal connection fail, light keeps current state
	Dimmer	When DMX signal connection fail, light keeps dimming mode
	Program	When DMX signal connection fail, light keeps built in program mode

4. DMX Sync - In the DMX mode, several fixtures can also operate at the same step, even with no DMX control for a period of time. Please press the setup button to enter and select by the 'UP' or 'DOWN' button:

DMX Sync	On
	Off

5. Lock:

Lock	On
	Off

6. Factory - All data will restore to initial state after factory sets. Press the setup button to enter and select by the 'UP' or 'DOWN' button:

Factory	Yes
	No

**Information:** Store relevant information as follows. Press the setup button for 5 seconds, then input the password 0088 to clear the working time.

Information	Version x.x
	Temp: xx °C
	Work Time: xxxxxh
	UID:xxxxxxxxxxx



### RDM (Remote Device Management)

This product supports RDM communication protocol. RDM is a protocol that supports two-way traffic in the standard DMX512 protocol. RDM controls devices and configurations, and detects lights, changing the DMX address of the fixture, DMX mode, etc. Each RDM - compatible light can be identified by the built-in unique UID code.

Parameter ID	Discovery Command	SET command	Get Command
DISC_UNIQUE_BRANCH	*		
DISC_MUTE	*		
DISC_UN-MUTE	*		
DEVICE_INFO			*
SOFTWARE_VERSION_LABEL			*
DMX_START_ADDRESS		*	*
IDENTIFY_DEVICE		*	*
SUPPORTED_PARAMETERS			*
SENSOR_DEFINITION			*
SENSOR_VALUE			*
DMX_PERSONALITY		*	*
DMX_PERSONALITY_DESCRIPTION			*
RESET_DEVICE		*	
FACTORY_DEFAULTS		*	

When the fixture is in INFO mode, press 'SET' and 'DOWN' button for 2 seconds to revise the UID mode.

### NOTES:

- If no buttons are pushed for 30 seconds, the screen will lock and show current operating mode, WDMX mode, temperature status and battery (this battery is reference value, changes for on and off is very large) To unlock press the 'MODE' and 'SETUP' buttons for 3 seconds.
- Press 'MODE' and 'SETUP' at the same time to quickly lock under unlock status.
- When the product powers on and shows version information, pressing the 'MODE' and 'SETUP' buttons at the same time for a few seconds. After this, it can restore factory settings and the data will be initialized.
- Please follow the user manual to ensure safe installation and operation.
- To prevent overheating, please use within the acceptable ambient temp range, 14° F to 104° F.
- Do not take down the light while it's plugged in.

**MENU INFO REFERENCE TABLE**

Menu 1	Menu 2	Menu 3	Description
1: DMX	1. Address	001 - 512	DMX Address
	2. Channels	4/6/10 - CH	DMX Mode
2: Dimmer	Red	000 - 255	Dimming mode
	Green	000 - 255	
	Blue	000 - 255	
	White	000 - 255	
3: AUTO	Yes/No		Auto Run Mode
4: Program	1. Mode	1 - 16	Built-in Program Mode
	2. Color [mode:1]	1 - 33	Static Color
	2. Speed [mode: 2-16]	1 - 100	Speed
	3. Strobe speed	0 - 99	Strobe
5: Slave	Yes/No		Slave
6: Settings	1. Curves Select	1 - 4	Dimming curve selection
	2. Dimmer Speed	Fast/Smooth	Dimming speed selection
	3. DMX Fail	Off/Hold/Dimmer/Program	DMX signal option
	4. DMX Sync	On/Off	DMX Synchronization setting
	5. Lock	On/Off	Standby lock screen
	6. Factory	Yes/No	Factory reset
7: Information	Versions: Vx.x.x		Version display
	Temperature: xx °C		Temperature detection
	Work Time: xxxxxh		Work time
	UID:xxxxxxxxxx		UID

**MOUNTING AND ALIGNMENT OF FIXTURE**

1. Mount and secure each fixture into the designated position in accordance to the installation plan. Ensure there is sufficient cable length between the fixture and junction box to allow for final alignment of the fixture.
2. Secure the fixtures to a solid mounting surface using three threaded fasteners minimum of 3/8 inch (10mm) stainless steel complete with flat and locking washer.
3. Rotate/tilt the fixture into the desired position.

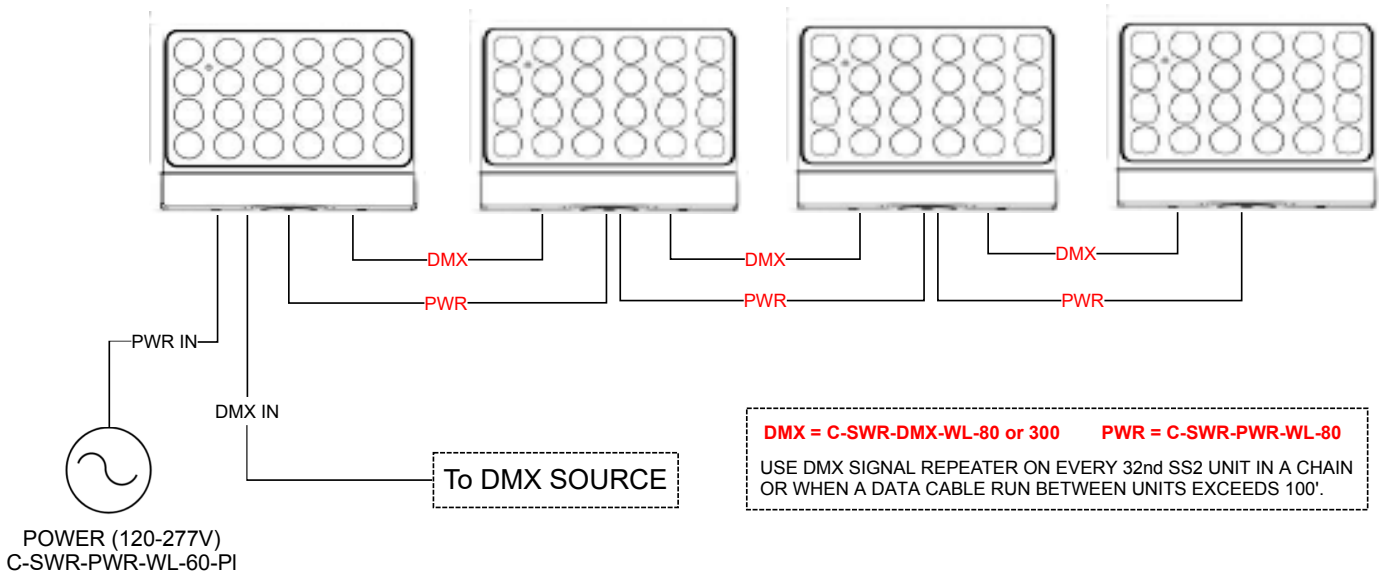

4-PIN INTERFACE		
Pin 1	+	Line Voltage
Pin 2	-	Neutral
Pin 3	Shield	Ground
Pin 4	Reserved	Leave Open

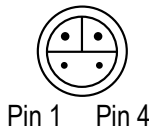

**REQUIRES ELECTRICIAN TO INSTALL**

NOTE: Supply lead wires should not be connected to a dimmer of any sort.

**DATA CONNECTION**

- Inline DMX amplifier required if run length exceeds: 125 feet between fixtures (others)
- Maximum run length from DMX controller to last fixture: 1000 feet
- DMX must be continuous from controller to last fixture in a run. A splitter is needed if signal is split
- If provided data cables won't be used, please note that any cables must meet EIA-RS485 requirements and warranty may be voided
- To comply with all local codes and jurisdiction, qualified communications technicians must do communications wiring
- To avoid signal transmission problems and interference, it is always advisable to connect to a DMX signal terminator
- Communication cables and AC power lines must not be run in the same conduit
  - Route Data Cables in series between fixture and any communications accessories using DATA IN and DATA OUT
  - To ensure they are easily accessed once construction is complete, secure data cables near the fixtures

## MAINTENANCE

We recommend periodic cleaning. Over time these components can become dirty or full of debris. This can result in lack of cooling or can limit the capabilities of the fixture. **Lens:** Clean the front Lexan® as required using window cleaner or mild soap and water. Dry with a quality paper towel to avoid scratches or streaks. **Mounts/Fasteners:** Check annually for tightness and security to avoid damage to the fixture and possible liability.

## TROUBLESHOOTING

If problems occur during usage, unplug the product immediately and email [support@novaflexled.com](mailto:support@novaflexled.com) or call 800-595-6302.

**Replacing a Failed Fixture:** "Hot Swapping" a fixture is not allowed. If a fixture needs to be replaced, the steps are to:

1. Disconnect the DMX **input** at the junction box of the fixture needing replacement, THEN disconnect DMX **output**
2. Replace fixture
3. Reconnect AC **negative**, THEN AC **positive**
4. Reconnect DATA **output**, THEN DATA **input**
5. Reconnect power and make sure the replaced fixture and the entire system is in working order

**If fixture does not light, check if:**

- Electrical power is not connected.
- Electrical power is less than specific voltage.
- Electrical power is greater than specified voltage.

**If fixture does not respond to DMX control signal, check if:**

- DMX control device and RGBW are addressed differently.
- DMX cable is damaged.
- DMX control device is disconnected or not operating.
- DMX device needs to be restarted.
- LED fixture was not restarted after address change.
- Restart fixture.

**If the fixture is not responding to DMX, check if:**

- DMX addressing is incorrect: Check Control Panel and unit addressing.
- The wrong polarity settings may be on the controller: Check polarity switch settings on the controller.
- DMX cables may be loose: Check cable connectors.

**If DMX control operation flickers or is intermittent, check if:**

- RGBW fixture or final DMX device in daisy chain is not terminated.
- DMX cable is damaged.
- DMX control device is operating at less than 25Hz.

**If there is a loss of signal, check if:**

- Non-DMX cables are being used: Use only DMX compatible cables
- Signals are bouncing: DMX terminator is not installed as suggested.

**If output is less than normal, check if:**

- Environment temperature may be in excess of 114°F/45°C.
- Lens may be damaged or dirty.
- DMX control or RGBW channels may be set at low level.

View [Nova Flex Terms & Conditions](#) for more details.