



- Dimmable architectural-grade (dot-free)
- Great for long runs up to 164 feet to outline buildings, coves or landscape applications
- Indoor / outdoor rated
- No external driver required
- ETL Listed with hardwire or plug option
- UV resistant
- Over-voltage/-current/-temp protection
- Professional, streamlined custom-finish with 5 - 7 week lead time



Create a complete assembled solution.

Project Name _____

Fixture Type _____ Phase _____

Specifier _____ Date _____

SKU _____ SKU _____

SKU _____ SKU _____

PERFORMANCE

SKU	CCT	Peak Wave Length (nm)	FWHM (nm)	L/ft	EFFICACY (L/w)
● NF/SP-NEON-0-120V-SB-R	red	657	82	14	5
● NF/SP-NEON-0-120V-SB-G	green	502	43	83	28
● NF/SP-NEON-0-120V-SB-B	blue	460	24	10	3
● NF/SP-NEON-0-120V-SB-A	amber	620	102	57	19
● NF/SP-NEON-0-120V-SB-P	pink	N/A	N/A	47	16

QUALITY ASSURANCE

CCT Binning	3-step MacAdam
Warranty	5 Years Indoor 3 Years Outdoor <small>Warranty is 4 years for indoor and 2 years for outdoor for applications requiring more than 16 hours of daily use</small>
Lumen Maintenance	Indoor 50,000 hrs Outdoor 36,000 hrs
Certifications	ETL Listed RoHS compliant

ELECTRICAL

Power	3 w/ft
Voltage	120V
Wire Size	18 AWG
Lead	1.64' / 4.92'
Jumper	3" min / 48" max

Compatible Dimmers (take care not to exceed dimmer's power rating, recommended max lengths noted below):

- Dimming
- Triac, Lutron DVCL-153P (max 133')
 - Triac, Lutron DVELV-300P (max 66')
 - Triac, Lutron DVLV-10P (all lengths, up to 164' max run of strip)

PHYSICAL

Ambient Temp	-4° to 113°F
Environment	IP65
Mounting	Clips or Channel (rigid or bendable)
Cut Length	12.0"
Bend Diameter	4.72"
Max Run	164 ft
Dimensions	width 0.39" height 0.79"

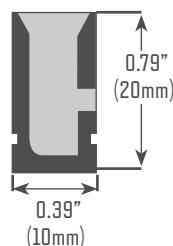

LIGHT DIST (RED)

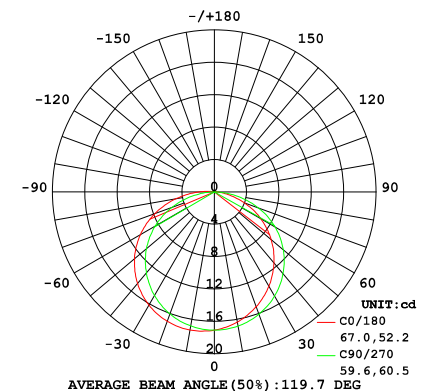

Beam Angle



[DOWNLOAD PHOTOMETRICS](#)

INJECTION MOLDED LEAD OPTIONS

BACK
with plug
or hardwire

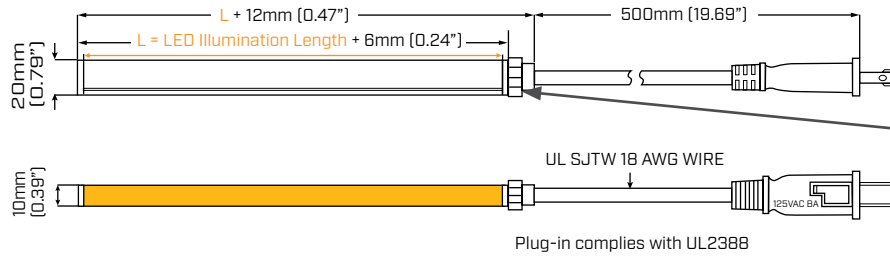



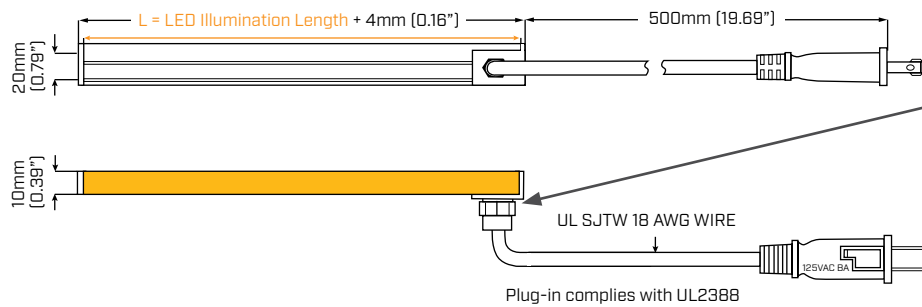

SIDE (left or right)
with plug
or hardwire

* This drawing is showing the left side



MOUNTING OPTIONS *For all ceiling installations, we recommend the use of either the bendable serrated profile, or the rigid aluminum profile*

SKU	Dimensions	Mounting
 NF/SP-CH-NEON-120V-SB-BRACKET White Aluminum Bracket	width: 0.39" height: 0.79" length: 0.72"	1 clip every 18" mounts behind neon (1 screw/clip, 2 clips/pack)
 NF/SP-CH-NEON-120V-SB-CLIP Clear PC Clip	width: 1.25" (includes flanges for screws) height: 0.88" length: 0.56"	1 clip every 18" mounts over front of neon (2 screws/clip, 2 clips/pack)
 NF/SP-CH-NEON-120V-SB-FLEX Silver Bendable, Serrated Aluminum Profile	width: 0.51" height: 0.87" length: 1 meter	1 screw every 18" To secure this channel to the mounting surface, screws can be installed in the gaps at the bottom/base of the channel as needed. Screws can be installed on straight runs (gaps will be normal/ screws can secure the channel), and on the inside edges of curved runs. Screws won't fit on the outside edge, because the gaps will be too big. Neon body and end caps will fit into profile.
 NF/SP-CH-NEON-120V-SB-1M Silver Rigid Aluminum Profile	width: 0.51" height: 0.87" length: 1 meter	1 screw every 18" (channel has pre-drilled holes) Neon can be pressed into the channel, using even pressure, working from one end to the other. Neon body and end caps will fit into profile.

INSTALLATION: DIMMERS

Follow all notes in the install guide supplied with the dimmer. Use only with hardwired installation. **DO NOT INSTALL DIMMER TO control outlets / plug-in receptacles or use with other loads.**

LUTRON DVCL-153P

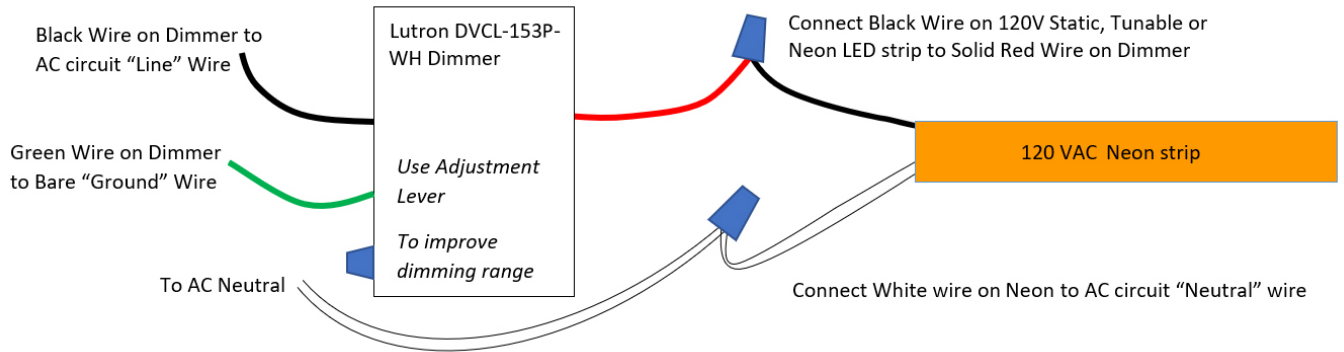

LUTRON DVELV-300P

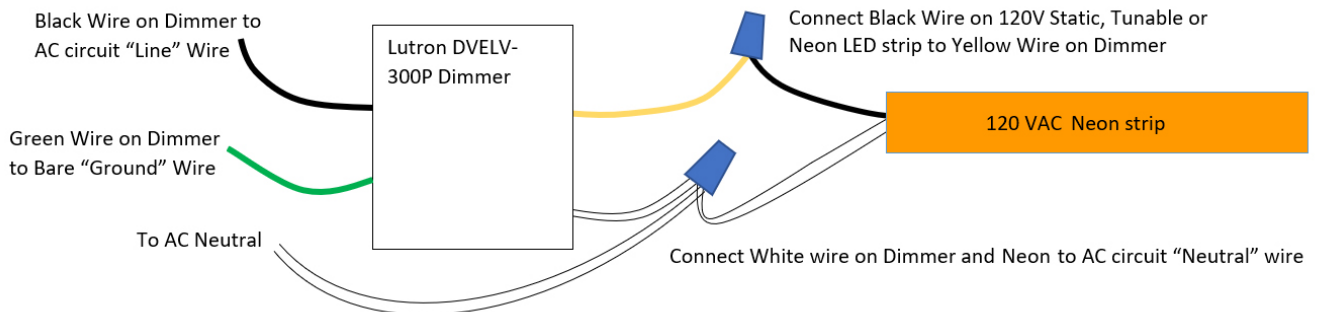

LUTRON DVLV-10P

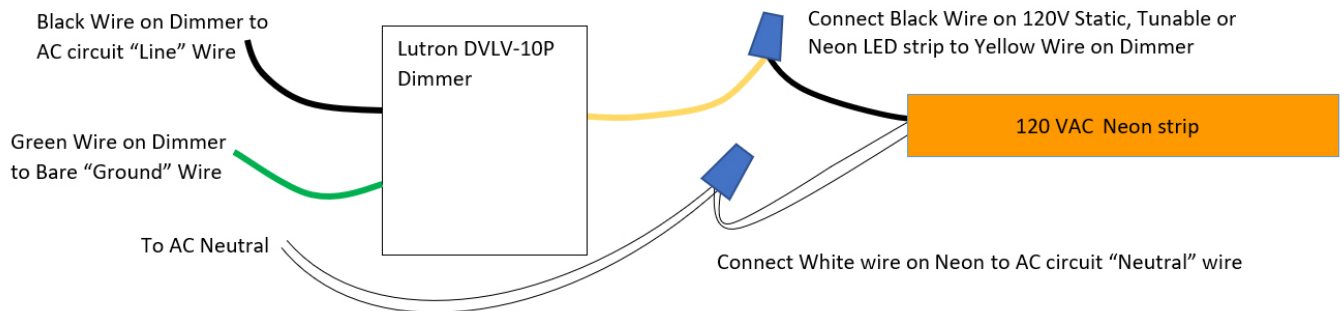

NOTE: Must use appropriate components that comply with local codes if installed outdoors (weather-proof connectors, cord covers, enclosures, etc). This product is NOT field-cuttable, which would void the IP rating and warranty.